

2R150SD

Trituratori industriali
Industrial shredders

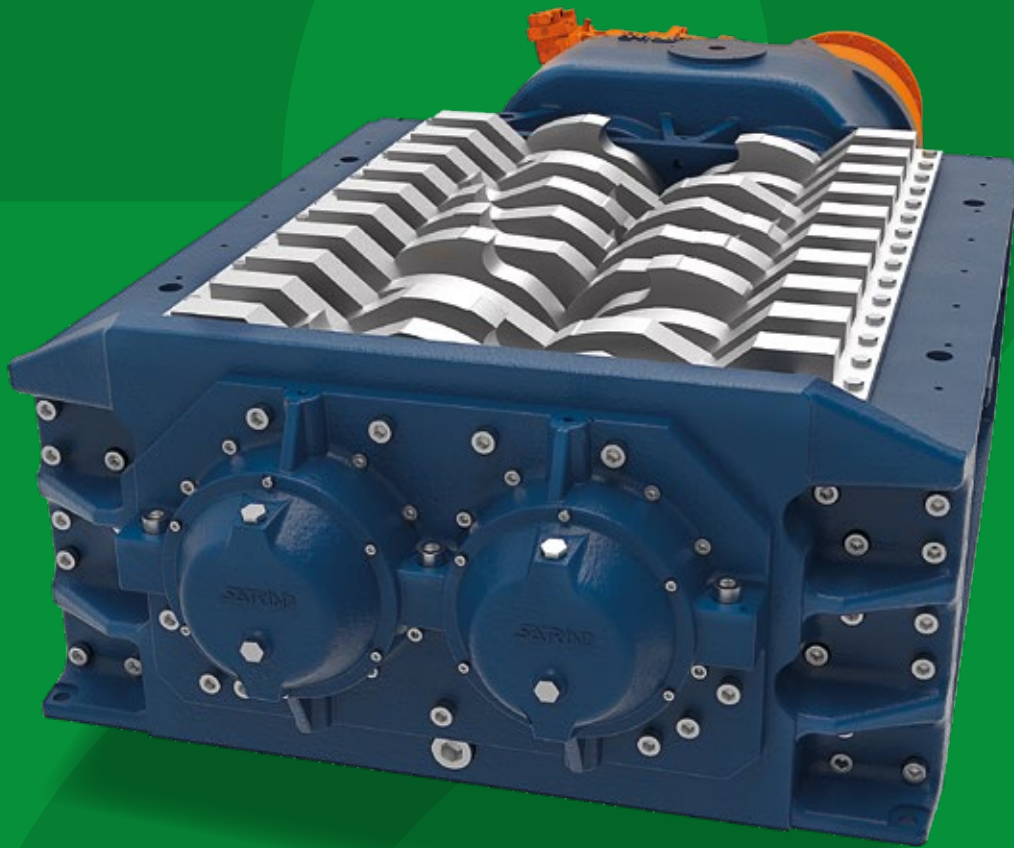

2 alberi / Azionamento idraulico
2 shaft / Hydraulic drive

110 kW

2R150SD

Made in Italy 

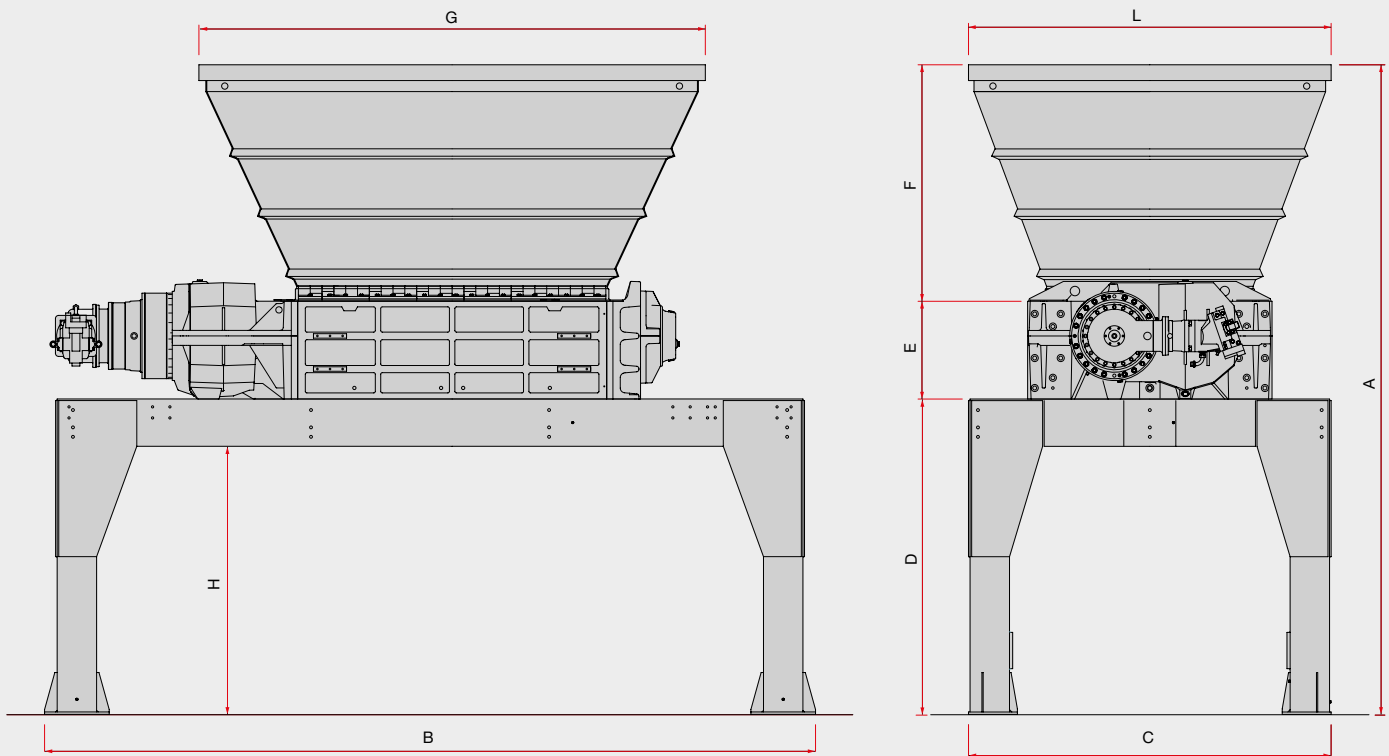





Dimensioni - Dimensions

Modello Model	A mm	B mm	C mm	D mm	E mm	F mm	G mm	H mm	L mm
2R15/150SD	4120	4440	2300	2000	620	1500	2760	1700	2300

Dati tecnici - Technical data

Modello Model	Camera di lavoro Shredding chamber	Spessore lame Blades thickness	Potenza Power	Peso Weight
2R15/150SD	1510x1100 mm	50 - 75 mm	110 kW	13100+2180 kg

Applicazioni - Applications

	Rifiuti industriali Industrial scraps/waste	6-8
	Pneumatici Tyres	6-8
	Rifiuti solidi urbani Municipal solid waste	10-20
	Fusti di metallo Metal drums	100-160 pcs/h
	Rifiuti ingombranti Bulky waste	4-6
	Materiale - Material	t/h