

3R75ER

Trituratori industriali
Industrial shredders



3 alberi / Azionamento elettrico

3 shaft / Electric drive

55,5 kW

3R75ER

Made in Italy 

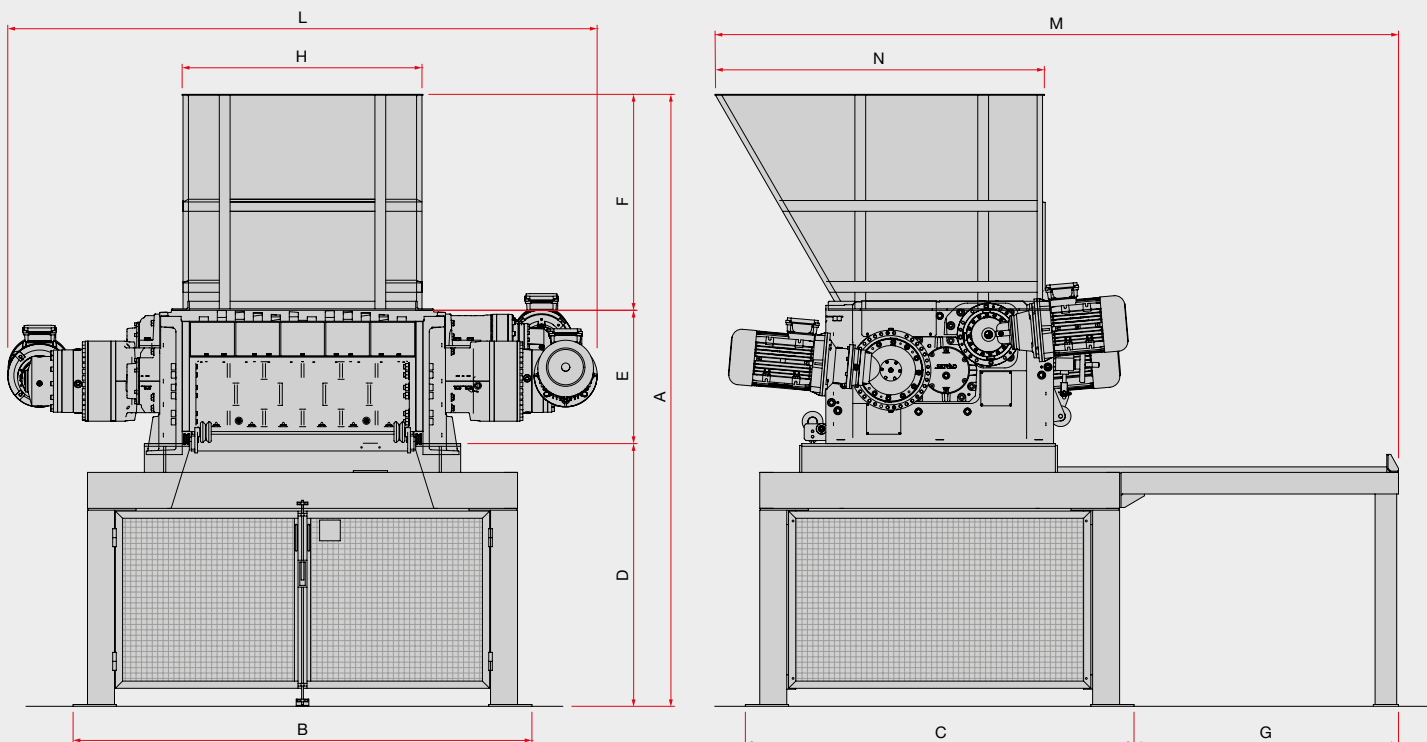





Dimensioni - Dimensions

Modello Model	A mm	B mm	C mm	D mm	E mm	F mm	G mm	H mm	L mm	M mm	N mm
3R10/75ER	3400	2550	2160	1460	740	1200	1470	1080	3030	3800	1830
3R13/75ER	3400	2550	2160	1460	740	1200	1470	1330	3280	3800	1830

Dati tecnici - Technical data

Modello Model	Camera di lavoro Shredding chamber	Spessore lame Blades thickness	Potenza Power	Peso Weight
3R10/75ER	1008x870 mm	30 - 50 mm	55,5 (22+18,5+15) kW	6100 kg
3R13/75ER	1258x870 mm	30 - 50 mm	55,5 (22+18,5+15) kW	7300 kg

Applicazioni - Applications

	Rifiuti ospedalieri Hospital waste	1500-2500
	Plastica Plastics	1500-2000
	Rifiuti industriali Industrial scraps/waste	1000-2000
	Legno Wood	1500-2000
	Rifiuti elettronici WEEE	1500-2000
Materiale - Material		kg/h